

NDP4050 / NDB4050 N-Channel Enhancement Mode Field Effect Transistor

General Description

These N-Channel enhancement mode power field effect transistors are produced using Fairchild's proprietary, high cell density, DMOS technology. This very high density process has been especially tailored to minimize on-state resistance, provide superior switching performance, and withstand high energy pulses in the avalanche and commutation modes. These devices are particularly suited for low voltage applications such as automotive, DC/DC converters, PWM motor controls, and other battery powered circuits where fast switching, low in-line power loss, and resistance to transients are needed.

Features

- 15A, 50V. $R_{DS(ON)} = 0.10\Omega @ V_{GS}=10V$.
- Critical DC electrical parameters specified at elevated temperature.
- Rugged internal source-drain diode can eliminate the need for an external Zener diode transient suppressor.
- 175°C maximum junction temperature rating.
- High density cell design for extremely low $R_{DS(ON)}$.
- TO-220 and TO-263 (D²PAK) package for both through hole and surface mount applications.

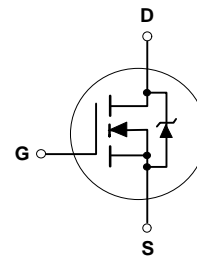
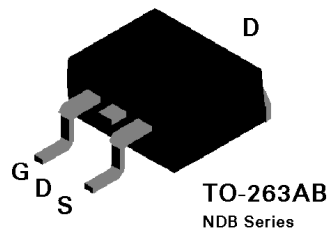
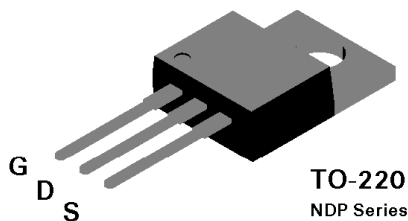

Absolute Maximum Ratings $T_c = 25^\circ\text{C}$ unless otherwise noted

| Symbol | Parameter | NDP4050 | NDB4050 | Units |
|----------------|--|------------|---------|-------|
| V_{DS} | Drain-Source Voltage | 50 | | V |
| V_{DGR} | Drain-Gate Voltage ($R_{GS} \leq 1\text{ M}\Omega$) | 50 | | V |
| V_{GSS} | Gate-Source Voltage - Continuous - Nonrepetitive ($t_p < 50\ \mu\text{s}$) | ± 20 | | V |
| | | ± 40 | | |
| I_D | Drain Current - Continuous - Pulsed | ± 15 | | A |
| | | ± 45 | | |
| P_D | Total Power Dissipation Derate above 25°C | 50 | | W |
| | | 0.33 | | |
| T_J, T_{STG} | Operating and Storage Temperature Range | -65 to 175 | | °C |
| T_L | Maximum lead temperature for soldering purposes, 1/8" from case for 5 seconds | 275 | | °C |

Electrical Characteristics ($T_c = 25^\circ\text{C}$ unless otherwise noted)

| Symbol | Parameter | Conditions | Min | Typ | Max | Units |
|--|--|---|---------------------------|-------|------|---------------|
| DRAIN-SOURCE AVALANCHE RATINGS (Note 1) | | | | | | |
| W_{DSS} | Single Pulse Drain-Source Avalanche Energy | $V_{DD} = 25\text{ V}$, $I_D = 15\text{ A}$ | | | 40 | mJ |
| I_{AR} | Maximum Drain-Source Avalanche Current | | | | 15 | A |
| OFF CHARACTERISTICS | | | | | | |
| BV_{DSS} | Drain-Source Breakdown Voltage | $V_{GS} = 0\text{ V}$, $I_D = 250\ \mu\text{A}$ | 50 | | | V |
| I_{DSS} | Zero Gate Voltage Drain Current | $V_{DS} = 50\text{ V}$, $V_{GS} = 0\text{ V}$ | | | 250 | μA |
| | | | $T_J = 125^\circ\text{C}$ | | 1 | mA |
| I_{GSSF} | Gate - Body Leakage, Forward | $V_{GS} = 20\text{ V}$, $V_{DS} = 0\text{ V}$ | | | 100 | nA |
| I_{GSSR} | Gate - Body Leakage, Reverse | $V_{GS} = -20\text{ V}$, $V_{DS} = 0\text{ V}$ | | | -100 | nA |
| ON CHARACTERISTICS (Note 1) | | | | | | |
| $V_{GS(th)}$ | Gate Threshold Voltage | $V_{DS} = V_{GS}$, $I_D = 250\ \mu\text{A}$ | 2 | 3 | 4 | V |
| | | | $T_J = 125^\circ\text{C}$ | 1.4 | 2.4 | |
| $R_{DS(on)}$ | Static Drain-Source On-Resistance | $V_{GS} = 10\text{ V}$, $I_D = 7.5\text{ A}$ | | 0.078 | 0.1 | Ω |
| | | | $T_J = 125^\circ\text{C}$ | | 0.12 | |
| $I_{D(on)}$ | On-State Drain Current | $V_{GS} = 10\text{ V}$, $V_{DS} = 10\text{ V}$ | 15 | | | A |
| g_{FS} | Forward Transconductance | $V_{DS} = 10\text{ V}$, $I_D = 7.5\text{ A}$ | 3 | 5.7 | | S |
| DYNAMIC CHARACTERISTICS | | | | | | |
| C_{iss} | Input Capacitance | $V_{DS} = 25$, $V_{GS} = 0\text{ V}$, $f = 1.0\text{ MHz}$ | | 370 | 450 | pF |
| C_{oss} | Output Capacitance | | | 165 | 200 | pF |
| C_{rss} | Reverse Transfer Capacitance | | | 50 | 100 | pF |
| SWITCHING CHARACTERISTICS (Note 1) | | | | | | |
| $t_{D(on)}$ | Turn - On Delay Time | $V_{DD} = 30\text{ V}$, $I_D = 15\text{ A}$ $V_{GS} = 10\text{ V}$, $R_{GEN} = 25\ \Omega$ | | 8 | 20 | ns |
| t_r | Turn - On Rise Time | | | 70 | 100 | ns |
| $t_{D(off)}$ | Turn - Off Delay Time | | | 18 | 30 | ns |
| t_f | Turn - Off Fall Time | | | 37 | 50 | ns |
| Q_g | Total Gate Charge | $V_{DS} = 48\text{ V}$ $I_D = 15\text{ A}$, $V_{GS} = 10\text{ V}$ | | 12.7 | 17 | nC |
| Q_{gs} | Gate-Source Charge | | | 3.2 | | nC |
| Q_{gd} | Gate-Drain Charge | | | 7 | | nC |

Electrical Characteristics ($T_c = 25^\circ\text{C}$ unless otherwise noted)

| Symbol | Parameter | Conditions | Min | Typ | Max | Units |
|---|---|---|---------------------------|------|------|---------------------------|
| DRAIN-SOURCE DIODE CHARACTERISTICS AND MAXIMUM RATINGS | | | | | | |
| I_s | Maximum Continuous Drain-Source Diode Forward Current | | | | 15 | A |
| I_{SM} | Maximum Pulsed Drain-Source Diode Forward Current | | | | 45 | A |
| V_{SD} | Source-Drain Diode Forward Voltage | $V_{GS} = 0\text{ V}$, $I_s = 7.5\text{ A}$ (Note 1) | | 0.95 | 1.3 | V |
| | | | $T_J = 125^\circ\text{C}$ | 0.88 | 1.2 | |
| t_{rr} | Reverse Recovery Time | $V_{GS} = 0\text{ V}$, $I_F = 15\text{ A}$, $di_F/dt = 100\text{ A}/\mu\text{s}$ | 25 | 46 | 100 | ns |
| I_{rr} | Reverse Recovery Current | | 1.5 | 3.4 | 7 | A |
| THERMAL CHARACTERISTICS | | | | | | |
| $R_{\theta JC}$ | Thermal Resistance, Junction-to-Case | | | | 3 | $^\circ\text{C}/\text{W}$ |
| $R_{\theta JA}$ | Thermal Resistance, Junction-to-Ambient | | | | 62.5 | $^\circ\text{C}/\text{W}$ |

Note:

1. Pulse Test: Pulse Width $\leq 300\ \mu\text{s}$, Duty Cycle $\leq 2.0\%$.

Typical Electrical Characteristics

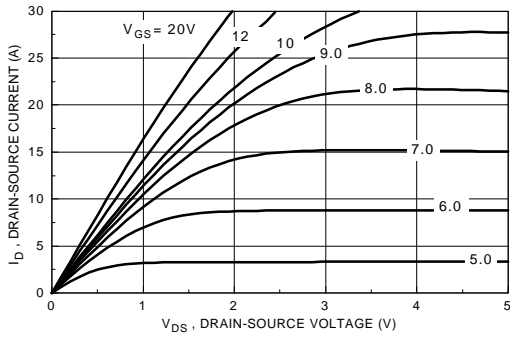

Figure 1. On-Region Characteristics.

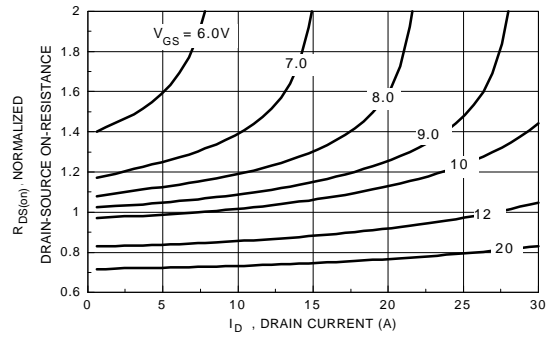

Figure 2. On-Resistance Variation with Gate Voltage and Drain Current.

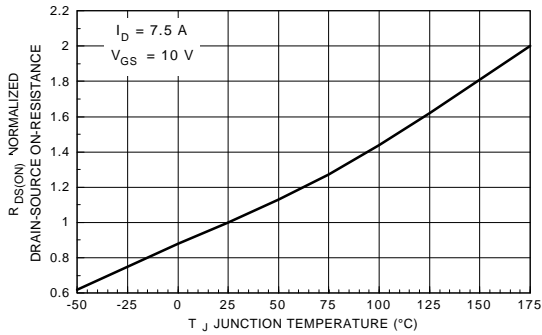

Figure 3. On-Resistance Variation with Temperature.

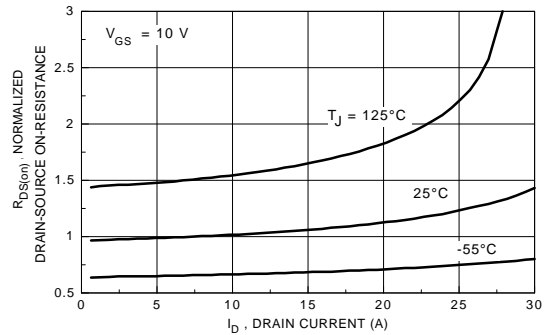

Figure 4. On-Resistance Variation with Drain Current and Temperature.

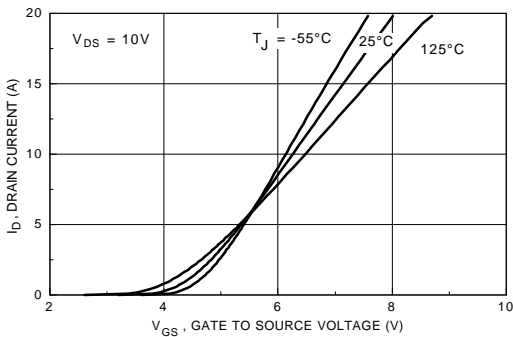

Figure 5. Drain Current Variation with Gate Voltage and Temperature.

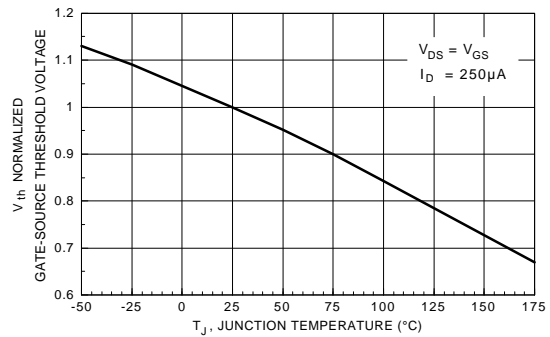

Figure 6. Gate Threshold Variation with Temperature.

Typical Electrical Characteristics (continued)

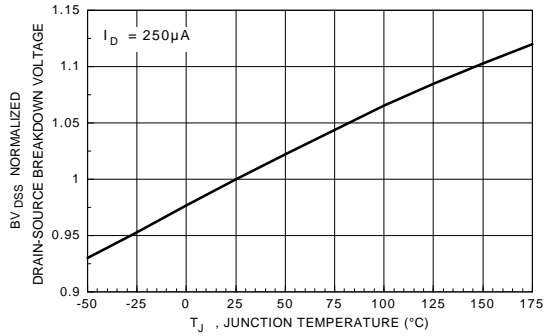

Figure 7. Breakdown Voltage Variation with Temperature.

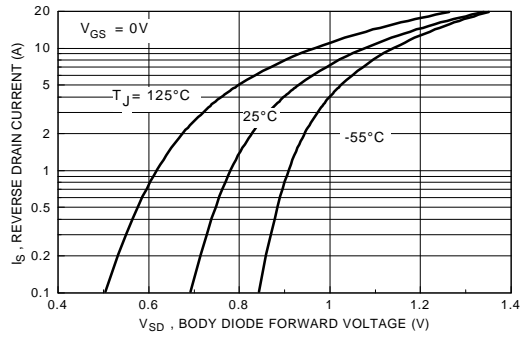

Figure 8. Body Diode Forward Voltage Variation with Current and Temperature.

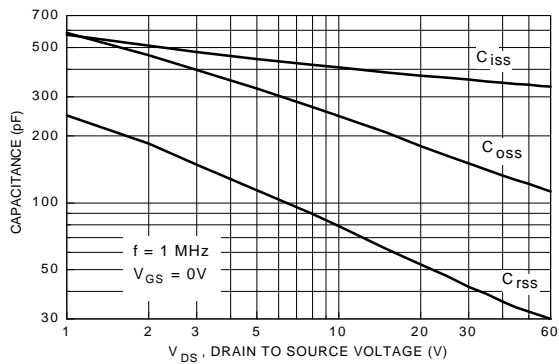

Figure 9. Capacitance Characteristics.

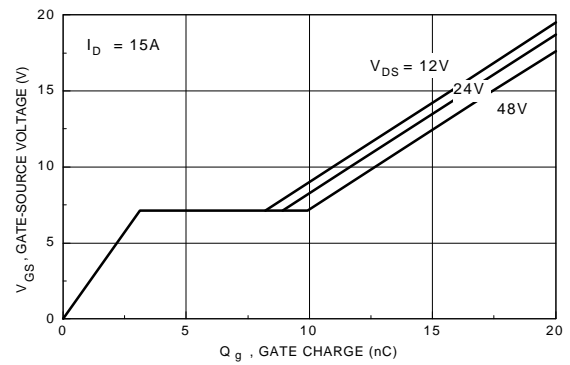

Figure 10. Gate Charge Characteristics.

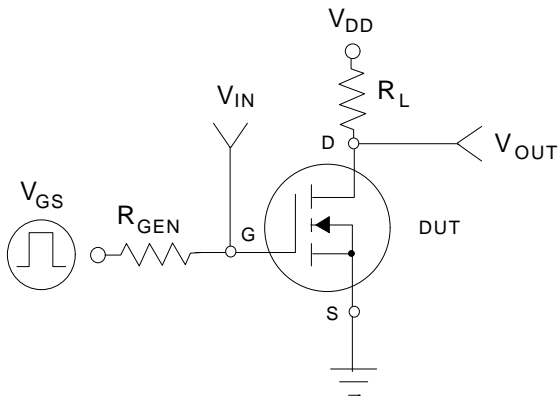

Figure 11. Switching Test Circuit.

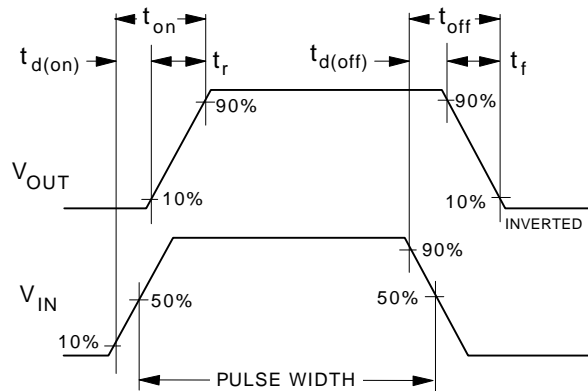

Figure 12. Switching Waveforms.

Typical Electrical Characteristics (continued)

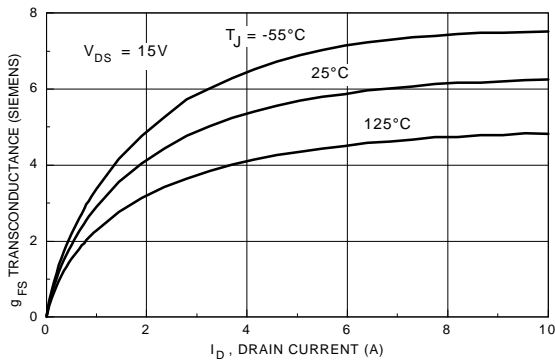

Figure 13. Transconductance Variation with Drain Current and Temperature.

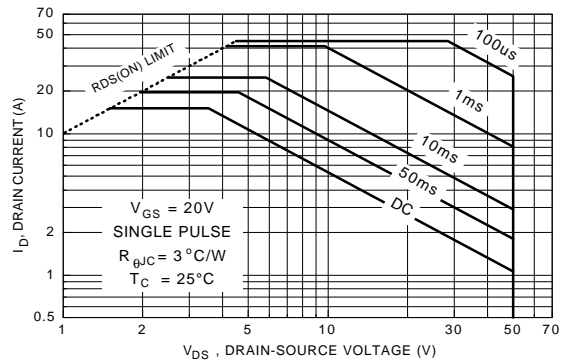

Figure 14. Maximum Safe Operating Area.

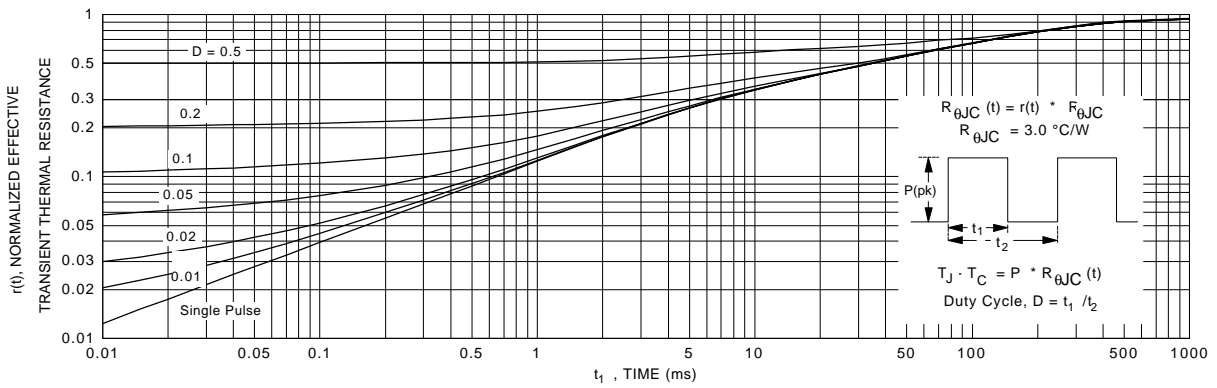

Figure 15. Transient Thermal Response Curve.